

**Jabra** GN

USER MANUAL



# PERFORM 75

Technology for life's new rhythm

© 2024 GN Audio A/S. All rights reserved. Jabra® is a trademark of GN Audio A/S. The Bluetooth® word mark and logos are registered trademarks owned by the Bluetooth SIG, Inc. and any use of such marks by GN Audio A/S is under license.

---

Made in Vietnam  
MODEL: OTE990



---

**Declaration of Conformity** can be found on  
[www.jabra.com/doc](http://www.jabra.com/doc)

1. Welcome.....	5
2. Overview.....	6
2.1 Included accessories	
2.2 Optional accessories	
2.3 First time use	
3. How to wear.....	9
3.1 Attaching and detaching the headset from the wearing style	
3.2 Replacing the ear cushions	
4. Labels .....	12
4.1 Label the headset and battery	
4.2 Label the headband	
5. How to charge.....	14
5.1 Charge using USB cable	
5.2 Charge using the charging station	
6. How to connect.....	16
6.1 Power on	
6.2 Power off	
6.3 Pair with a Bluetooth device	
6.4 Connect to your Bluetooth device using NFC	
6.5 Pair with QR code scanner	

7. How to use .....	20
7.1 Calls	
7.2 The Customizable button	
7.3 Multiple call handling	
7.4 Voice controls	
7.5 Reset the headset	
8. Jabra Direct.....	25
9. Support .....	26
9.1 FAQ	
9.2 How to care for your headset	
9.3 How to clean your headset	

# 1. Welcome

Thank you for using the Jabra Perform 75. We hope you will enjoy it!

Jabra Perform 75 features:

- **Rugged, lightweight, shift ready**, for use all day in challenging environments
- **99% noise-cancelling microphone** and crystal-clear sound keeps communication smooth
- **Push-to-Talk** lets you instantly communicate with colleagues
- **Easy to set up** and intuitive to use, with a durable, simple-to-sanitize design
- **Up to 20 hours of talk time**, and up to 100m / 300ft wireless range

## 2. Overview

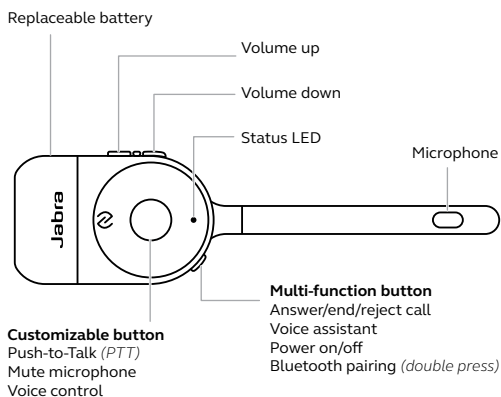

### 2.1 Included accessories

---

#### Ear Cushions



Leatherette

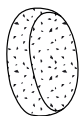

Foam

#### USB cable

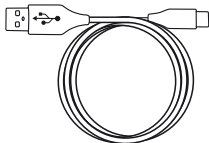

## 2.2 Optional accessories

---

Optional accessories are available at [jabra.com/accessories](http://jabra.com/accessories)

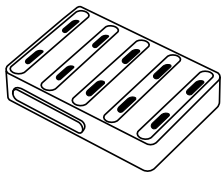

Jabra Perform 75  
10-Bay battery charging  
station

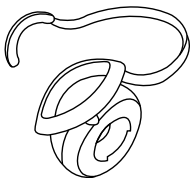

Jabra Perform 75  
neckband wearing style

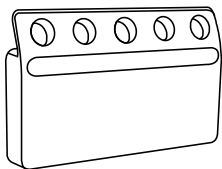

Jabra Perform 75  
organizer

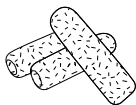

Jabra Perform 75  
microphone foam tip

## 2.3 First time use

---

The first time the battery is used it needs to be activated by either inserting into a charging station, or by connecting it to the headset and plugging the headset into a power source. The headset will not work until a battery that has been activated is plugged into it.

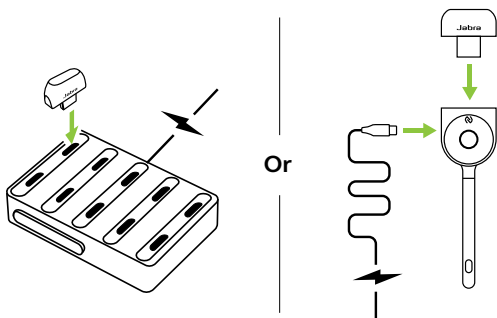

### **SECURITY NOTE:**

The battery detection sensor on the headset can potentially be used to detect the presence of a user.

### 3. How to wear

Adjust the headband so that the headset fits your head comfortably. The comfort pad should rest right above the ear.

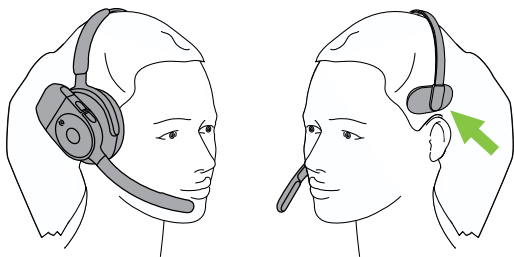

The headset can be worn with the microphone on the left or right side. It is important to position the microphone close to your mouth. The boom arm can be carefully bent for better positioning.

**SECURITY NOTE:**

Microphones can potentially be used to record private conversations.

### 3.1 Attaching and detaching the headset from the wearing style

---

The headset is designed to be easily attached and detached from the headband or neckband, as illustrated.

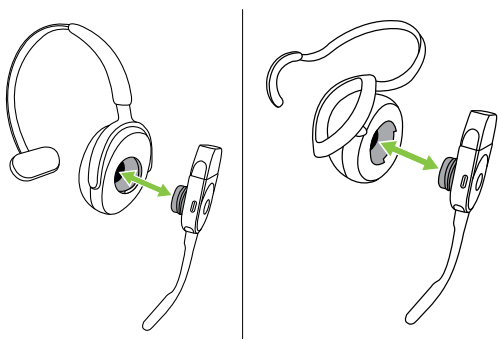

## 3.2 Replacing the ear cushions

---

The headset includes both a leatherette and foam cushion. The leatherette cushion provides better isolation from outside sound. The foam cushion is more breathable and better suited for warmer environments.

Detach ear cushion

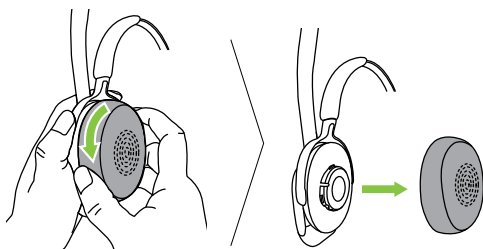

Reattach ear cushion

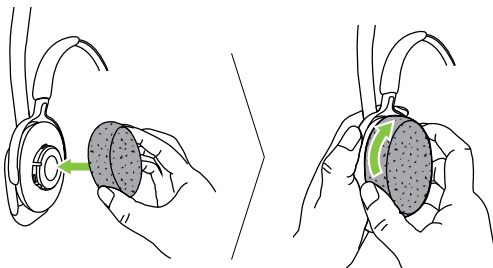

## 4. Labels

The headset is supplied with pre-attached and extra adhesive labels and transparent label covers. The labels can be used for identification or information.

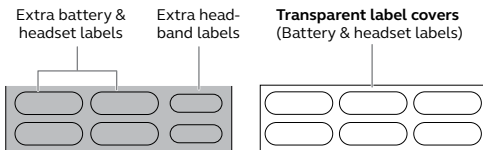
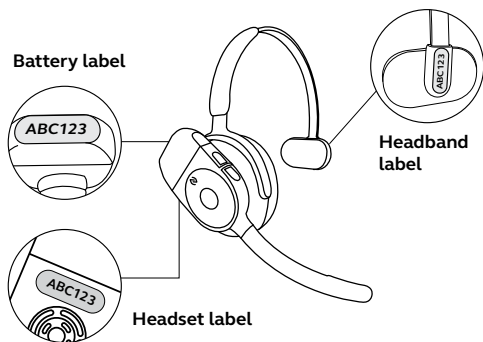

## 4.1 Label the headset and battery

---

The headset and battery labels come with transparent label covers that can be placed over the labels as protection. First, write a unique identifier on the pre-attached label on the headset or battery and then peel off a transparent label cover and attach it over the label. There are extra labels and label covers if needed.

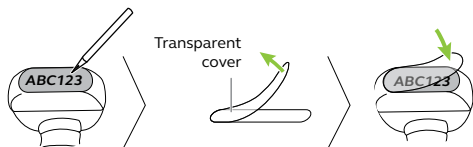

## 4.2 Label the headband

---

The headband labels are smaller than the headset and battery labels and do not include a transparent label cover. Simply write a unique identifier on the pre-attached label on the headband. There are extra labels if needed.

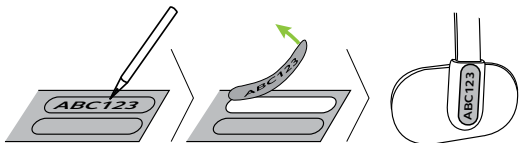

# 5. How to charge

## 5.1 Charge using USB cable

---

To charge the headset, connect the USB charging cable to the headset's USB-C charging port. It may take up to 180 minutes to fully charge the battery.

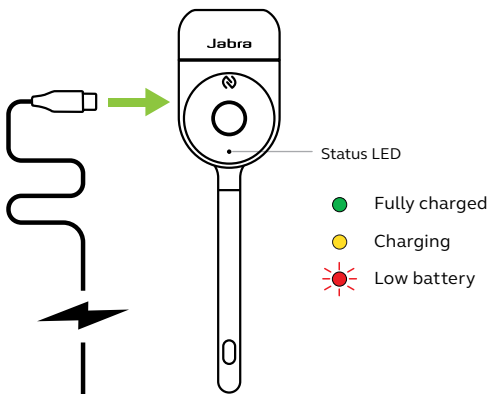

While charging, the LED indicator displays the charging status. Yellow indicates the headset is charging. Green indicates the headset is fully charged. The green LED will stay lit until the charging cable is unplugged.

## 5.2 Charge using the charging station

---

To charge the battery using the charging station, detach it from the headset and insert into an empty charging station bay. It may take up to 180 minutes to fully charge the battery.

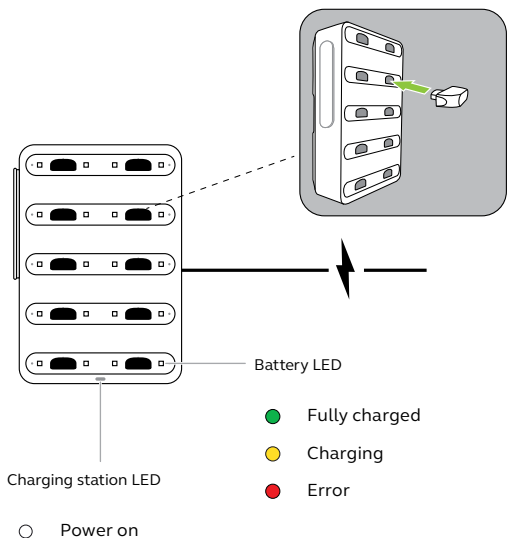

# 6. How to connect

## 6.1 Power on

---

Insert the battery or press the **Multi-function** button. The LED will flash green and you will hear “On”.

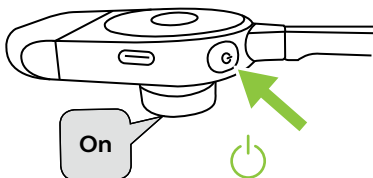

## 6.2 Power off

---

Press and hold the **Multi-function** button for 6 seconds until the LED flashes red and you hear “Off”.

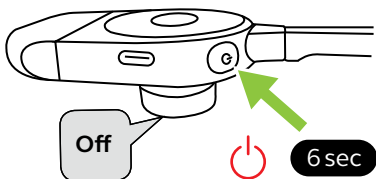

## 6.3 Pair with a Bluetooth device

---

1. Ensure the headset is powered on.
2. Double press the **Multi-function** button. The headset will announce “pairing” and the LED will flash red and blue. The headset is now ready to pair.
3. Go to the Bluetooth menu on your Bluetooth device and select the **Jabra Perform 75** from the list of available devices.

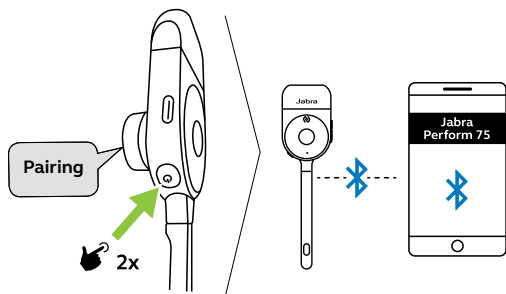

### SECURITY NOTE:

The headset uses a secure Bluetooth connection with an encryption key size of 128 bits. If your Bluetooth device does not support secure connections, it will not be able to pair or connect to the headset.

## 6.4 Connect to your Bluetooth device using NFC

---

1. Ensure that NFC is enabled on your device.
2. Place the NFC zone of your Bluetooth device against the NFC zone of the headset. The headset will turn on and your Bluetooth device will confirm the connection.
3. Select 'yes' or 'pair' to complete the pairing process.

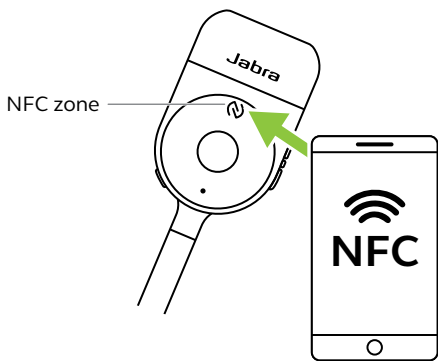

Please note that not all phones support NFC pairing.

### **SECURITY NOTE:**

The NFC sensor on the headset can potentially be used to detect the presence of a user.

## 6.5 Pair with QR code scanner

---

The headset can be paired to a device using a third-party QR code scanning app to scan the QR code on the headset. Refer to the pairing instructions in your third-party QR code scanning app for more details.

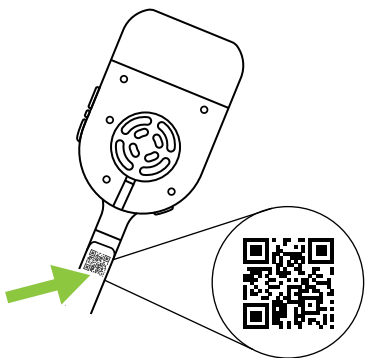

# 7. How to use

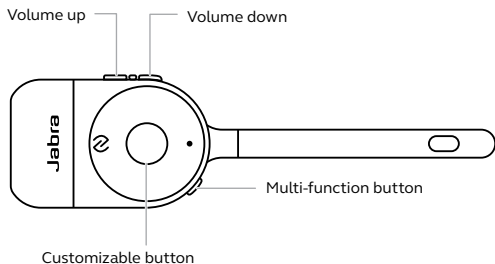

## 7.1 Calls

### What the buttons do



Answer call	Press the <b>Multi-function</b> button or say "Answer"
End call	Press the <b>Multi-function</b> button
Reject call	Press and hold (2 sec) the <b>Multi-function</b> button or say "Ignore"
Activate Voice Assistant (i.e. Siri, Google Assistant)	Press and hold (2 sec) the <b>Multi-function</b> button

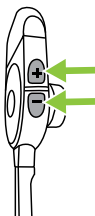

Adjust volume

Press the **Volume up** or **Volume down** button, when listening to music or on a call.

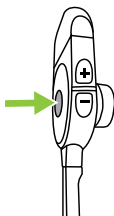

Mute/unmute microphone

Press the **Customizable** button when on a call. Note, when set on Voice control mode or Mute microphone mode.



Mute/unmute microphone and speaker during a call

Swivel the microphone up during a call to mute the microphone and speaker.\* Swivel the microphone down to unmute.

---

### SECURITY NOTE:

The boom-arm sensor can potentially be used to detect the presence of a user.

*\* Microphone and speaker mute can be configured using Jabra Direct.*

## 7.2 The Customizable button

---

By default, the Customizable button activates the voice controls, or mutes the microphone when on a call. However, the button can be configured for other functions, such as Push-to-Talk, battery status, and answer/end call.

To reconfigure the Customizable button, download and use Jabra Direct on your computer.

## 7.3 Multiple call handling

---

The headset can accept and handle multiple calls at the same time.

### Multiple call handling



End current call and answer incoming call

Press the **Multi-function** button to end the current call. Then press the **Multi-function** button to answer the incoming call

Put current call on hold and answer incoming call

Double press the **Multi-function** button

Reject incoming call when on a call

Press and hold (2 sec) the **Multi-function** button

## 7.4 Voice controls

---

The headset recognizes English voice commands, enabling call handling without touching the headset.

Press the **Customizable button** (when not on a call) to activate the voice controls. For a list of all available commands, say: “List Commands”

List of voice commands:

- “**Answer**” – answers an incoming call
- “**Ignore**” – rejects an incoming call and sends it to voicemail (if available)
- “**Pairing**” – puts the headset into pairing mode
- “**Connection Status**” – verifies that the headset is connected to a device
- “**Battery Status**” – announces battery level for the headset
- “**Cancel**” – cancels voice control

## 7.5 Reset the headset

---

Resetting the headset clears the list of paired devices and resets all settings.

1. Ensure the headset is powered on.
2. Press and hold (6 sec) both the **Volume down** button and the **Customizable** button until the LED flashes magenta and a confirmation tone is played in the headset.
3. The headset will automatically reboot.



You will need to re-pair the headset to your Bluetooth device after it has been reset. You will also need to clear the previous pairing to this headset on your Bluetooth device.

# 8. Jabra Direct

Jabra Direct is a desktop application designed to support, manage and enable optimal functionality for Jabra devices.

Download the latest free version from [jabra.com/direct](https://jabra.com/direct)

## 8.1 Update firmware

---

Firmware updates improve performance or add new functionality to Jabra devices.

Before first use of the headset, it is recommended to update it to the latest firmware. The headset firmware can be updated using either Jabra Direct on your computer.

# 9. Support

## 9.1 FAQ

---

View the FAQs at [jabra.com/help/perform75](https://jabra.com/help/perform75)

## 9.2 How to care for your headset

---

- To prevent the depletion of the battery lifetime or capacity, avoid storing the headset in hot or cold environments, such as a closed vehicle in summer or in winter conditions.
- For daily sanitization, 70% isopropyl alcohol wipes are recommended.
- When exposed to water, allow the headset sufficient time to dry. It may take up to one hour for the headset to dry thoroughly.
- Do not store the headset for extended periods of time without recharging them (max. three months).
- The headset uses the standard USB voltage of 5v +/- 0.25v. It is not recommended to charge the headset using a power supply with a higher voltage.

## 9.3 How to clean your headset

---

1. Apply normal dish soap and water to a cloth, making sure to wring out any excess liquid so the cloth is not dripping wet. Use soap and water only; do not use strong cleaning agents.
2. Gently wipe the headset with the wet cloth, making sure the headset is clean with no layer of suds on the surface.
3. Let the headset rest for at least one minute.
4. Wipe the headset clean with a cloth dampened with water only.
5. Allow the product to dry.